

## **What's in the Box**

## **Product Overview**

## **Button Guide**

Button Controls

Button Indicators

## **LCD Screen Guide**

## **Recharging the Power Station**

AC Recharging (1150W Max by Default)

Solar Panel Recharging (400W Max)

## **Charging Your Devices**

Turning On/Off the Power Station

AC Charging

SurgePad™

USB Charging

Uninterruptible Power Supply (UPS)

## **Using the App**



Adding the Device

Setting Up

Selecting Power Mode

## **Specifications**

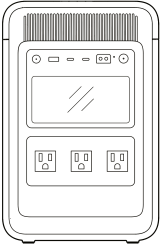
# What's in the Box

		
Anker SOLIX S2000 Portable Power Station	AC Charging Cable	Documents

# Product Overview

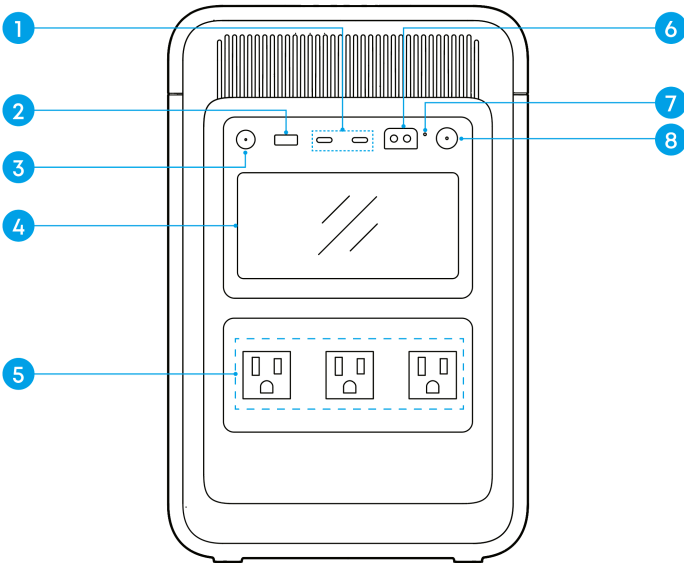
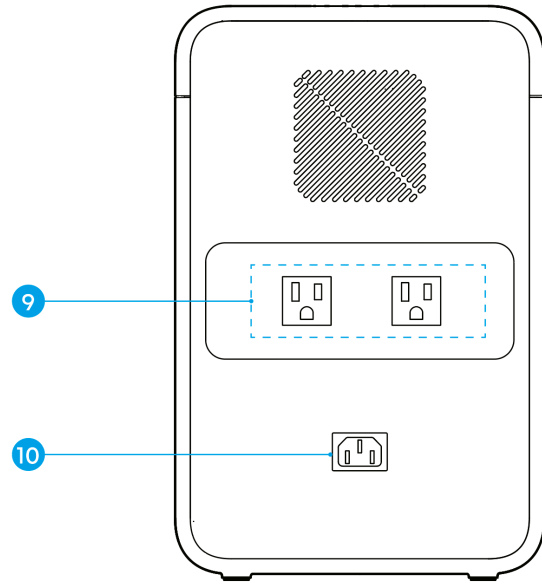
	<ul style="list-style-type: none"><li>1. USB-C Port</li><li>2. USB-A Port</li><li>3. AC Output Button</li><li>4. LCD Screen</li><li>5. AC Output Port</li><li>6. XT60i Input Port</li><li>7. Reset Hole</li><li>8. Main Power Button</li></ul>
	<ul style="list-style-type: none"><li>9. AC Output Port</li><li>10. AC Input Port</li></ul>

# Button Guide

## Button Controls

Button	Action	Function
<b>Main Power Button</b>	Press and hold for 3s	Power on/off
	Press briefly	Screen on/off
	Press briefly (during Bluetooth pairing)	Bluetooth authentication
	Press and hold for 7s (while powered off) *Note: Hold until the button indicators flashes rapidly, then release to confirm.	Reset Wi-Fi and disconnect Bluetooth.
<b>AC Output Button</b>	Press briefly	Turn AC output on/off
	Press and hold for 3s	Enable manual backup mode
<b>Main Power Button AC Output Button</b>	Press and hold the AC Output button, then press the Main Power Button 3 times within 3s	IOT on/off
<b>Reset Hole</b>	Insert a paper clip or pin into the reset hole for 1s	Reset the unit

## Button Indicators

Indicator	Status	Meaning
<b>Main Power Button LED Indicator</b>	Solid on	Unit is powered on
	Off	Unit is powered off
	Slow blinking	Awaiting Bluetooth authentication
	Fast blinking	Log upload in progress
<b>AC Output Button LED Indicator</b>	Solid on	AC output is on
	Off	AC output is off
	Blinking	AC output fault detected

# LCD Screen Guide

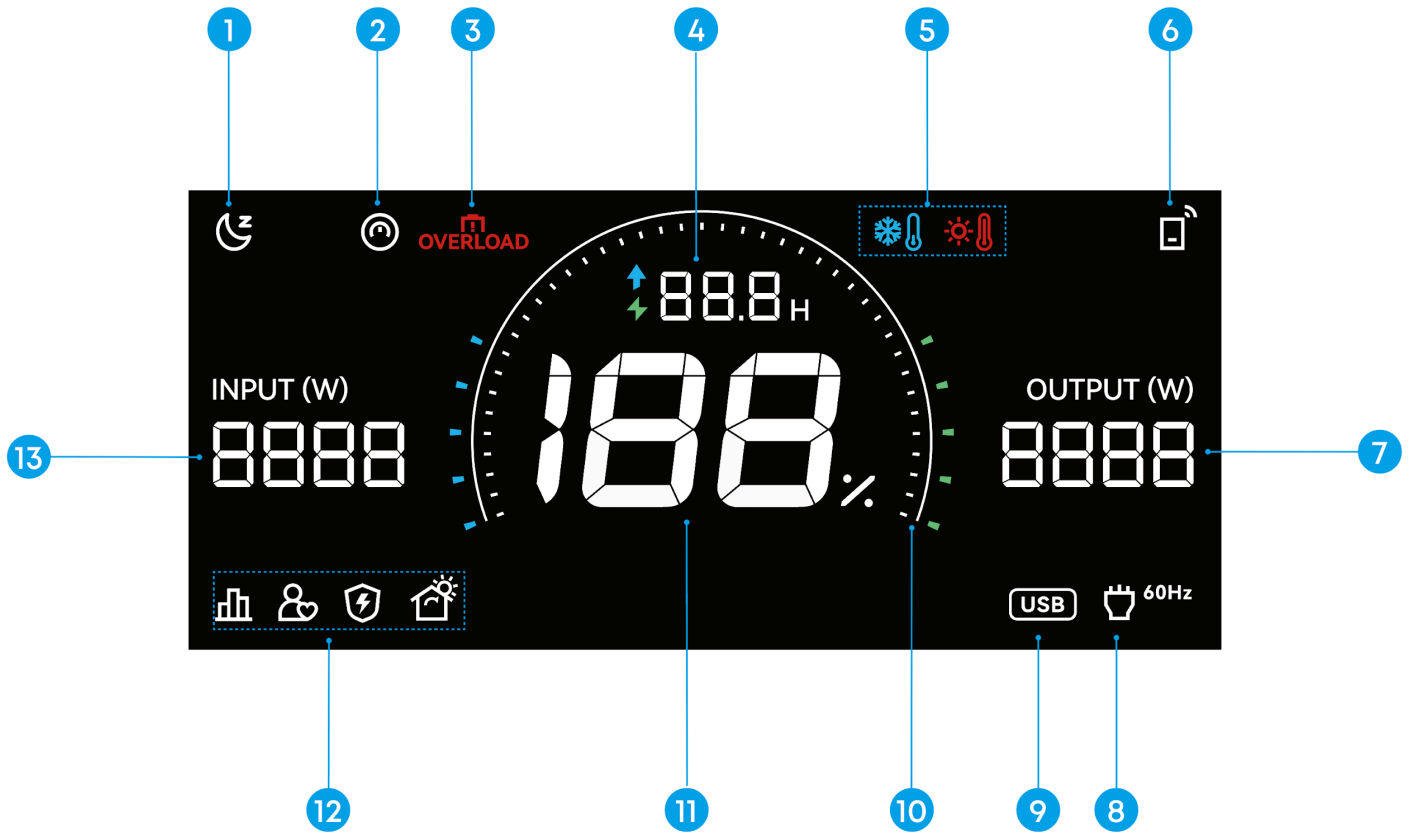

## 1. Silent Mode

## 2. Automatic Correction of Battery Level



If a charging/discharging limit is set, the power station will fully recharge to 100% after 720 hours of operation, regardless of mode or status. This calibrates the battery level. Once fully charged, the power station will return to the state or mode it was in prior to recharging.

## 3. Overload Warning

This icon appears when a port is overloaded. The port will be turned off to avoid any damage. Please remove the device causing overload.

## 4. Estimated Time to Charge / Discharge

## 5. High-Temperature / Low-Temperature Alert

	When this icon appears, stop using the power station and let it cool down until the icon disappears.
	When this icon appears, stop using the power station until the icon disappears.

## 6. Wi-Fi / Bluetooth Connection Status

## 7. Current Output Power

## 8. AC Output Icon

This icon lights up when the AC output button is pressed.





## 9. USB Output Icon

## 10. Charging/Discharging Limit

The lower limit can be set between 1% and 20%, while the upper limit can be set between 80% and 100% in the app.

## 11. Battery Level

## 12. Power Mode

	Time-of-Use (TOU) Mode
	Custom Mode
	Backup Mode
	Self-Consumption Mode

## 13. Current Input Power

# Recharging the Power Station

## AC Recharging (1150W Max by Default)

Recharge the power station by connecting to a wall outlet with the AC charging cable.



The AC port supports up to **1150W** input power by default. For faster charging, enable **UltraFast Recharging** in the Anker app to boost the power to **1600W Max**. To maintain optimal battery health, use this feature only when necessary.

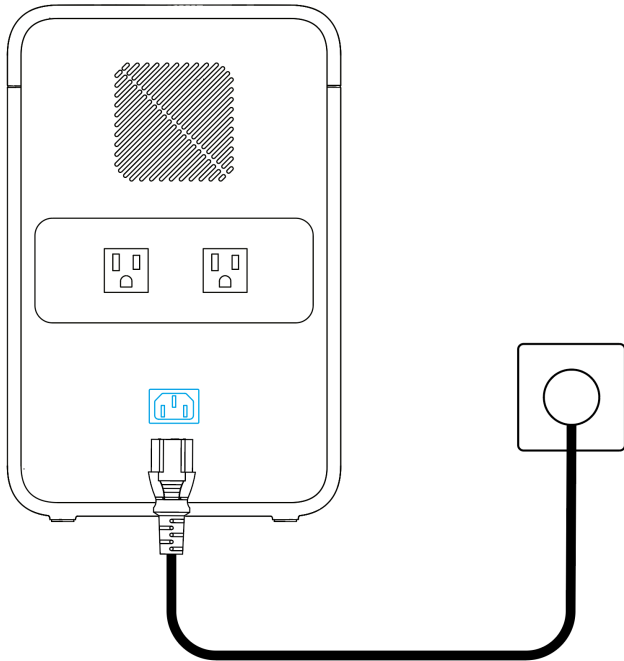

## Solar Panel Recharging (400W Max)

Recharge the power station by connecting the solar panel to the XT60i input port.



- The solar panels, the PV connector to XT60i charging cable, and the solar panel extension cables need to be purchased separately.
- The figure below shows an example of connecting two solar panels.

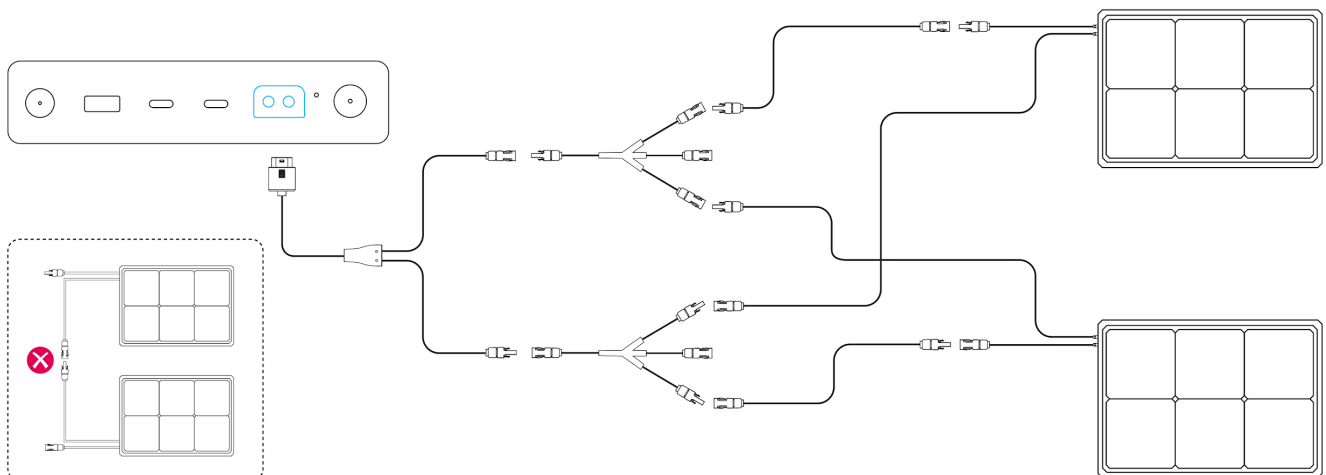

# Charging Your Devices

## Turning On/Off the Power Station

Press the main power button for 3 seconds to turn the power station on or off. Your power station is ready to charge devices once the “Battery Level” digits show on the LCD screen.



- Press the main power button once to turn the screen on. The screen will be turned off automatically after 30 seconds of lighting up. The auto-off time can be set in the Anker app.
- The default standby duration of the power station is 12 hours, which can be set in the Anker app.

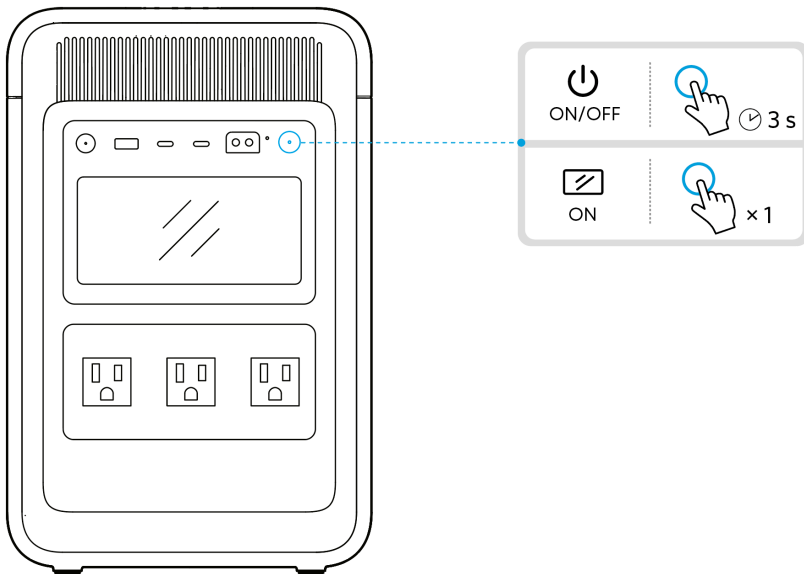

## AC Charging

Press the AC output button and connect your devices with the AC output ports.

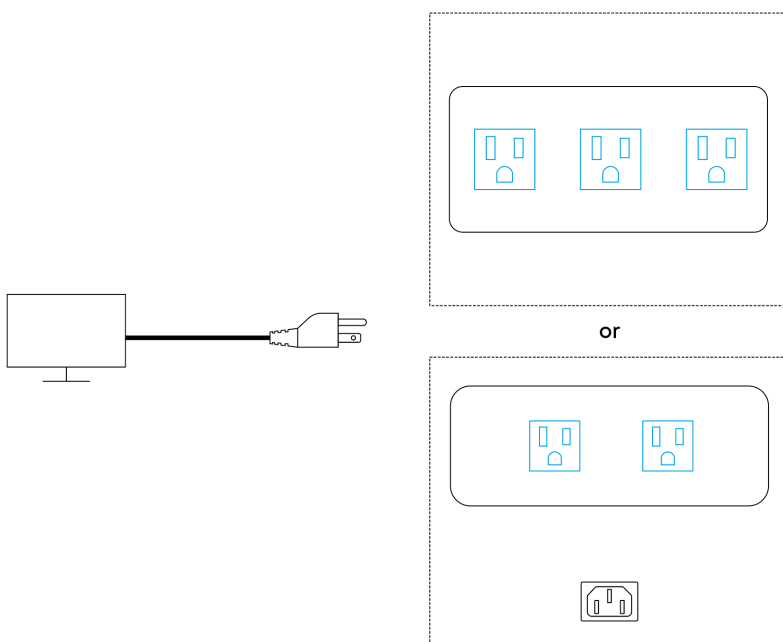

## SurgePad™

The power station supports the SurgePad™ feature for up to 2,600W AC output.

- SurgePad™ automatically turns on when the total output exceeds the rated output, allowing the power station to deliver power to high-wattage devices.
- SurgePad™ does not function in bypass mode (when the power station is being charged with the AC power).
- SurgePad™ works better with devices that generate heat, but does not support precision instruments and other devices that have voltage protection or strict voltage requirements. To see if SurgePad™ works with your high-wattage devices, try powering them with the power station.

## USB Charging

Connect your devices to USB ports.

To reduce power consumption and prolong the usage time, when the power station detects that the USB output power is less than 1W for a long time, it will determine that your device is fully charged and turn off the USB output automatically. To restart the output, just unplug and plug the USB cable again.

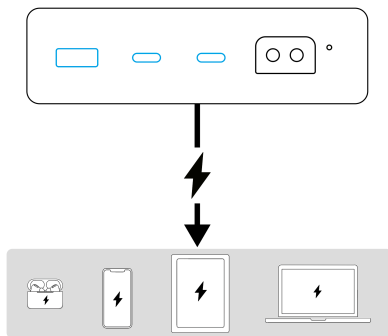

## Uninterruptible Power Supply (UPS)

To use the UPS feature, connect your power station to a wall outlet with the provided AC charging cable, then press the AC output button and connect your devices via the AC output ports. UPS supports 10 ms.

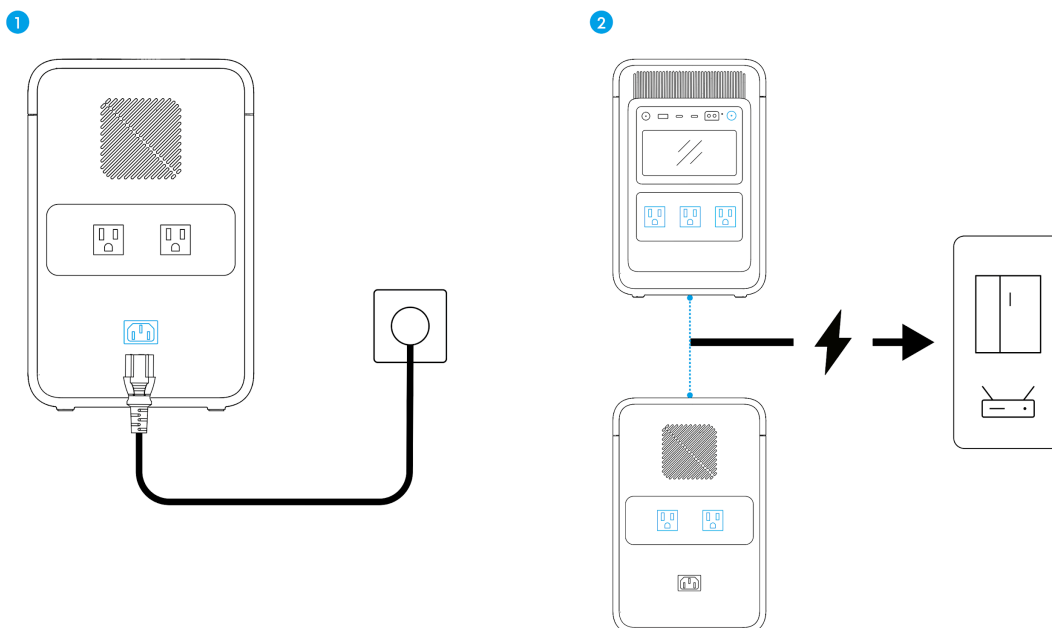

# Using the App



- You can remotely control your power station using the Anker app.
- The information below may not list all of the features available on the Anker app. To ensure access to new and improved features, download updated versions of the app as they become available.

## Adding the Device

1. Download the Anker app from the App Store (iOS devices) or Google Play (Android devices), or by scanning the QR code.

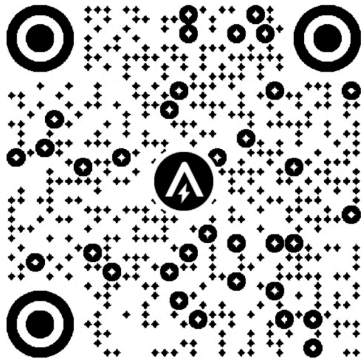

2. Sign in or create an account. Please be reminded that the country or region must match where you live. An incorrect country or region may cause the device connection to fail.

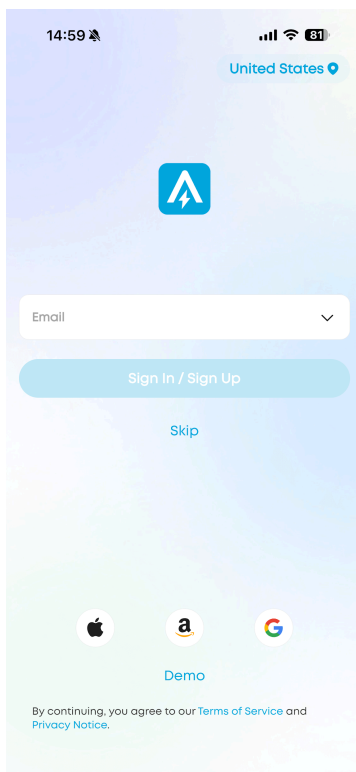

### 3. Follow the in-app instructions to add S2000.

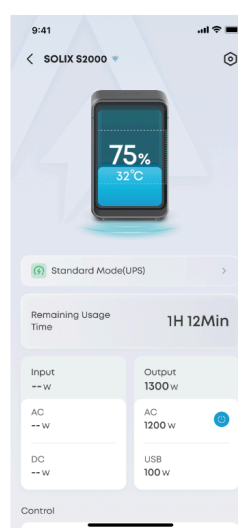
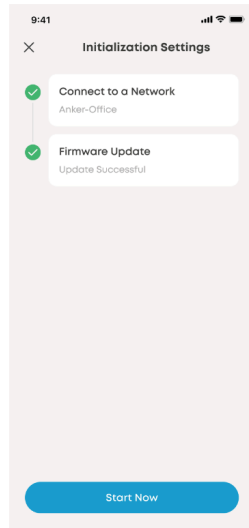
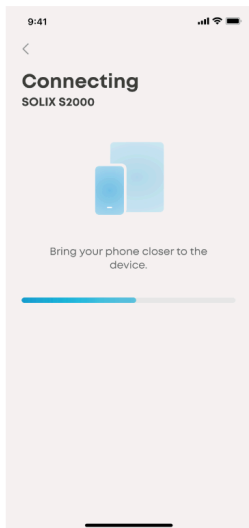
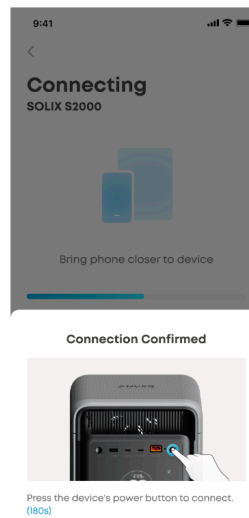
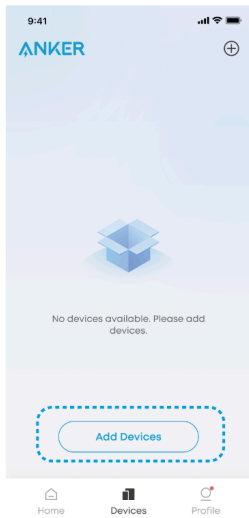

# Setting Up

## Silent Mode

1. Tap **Silent Mode** to turn it on.
2. Select repeat days and set the Start/End time. Then tap **Save**.

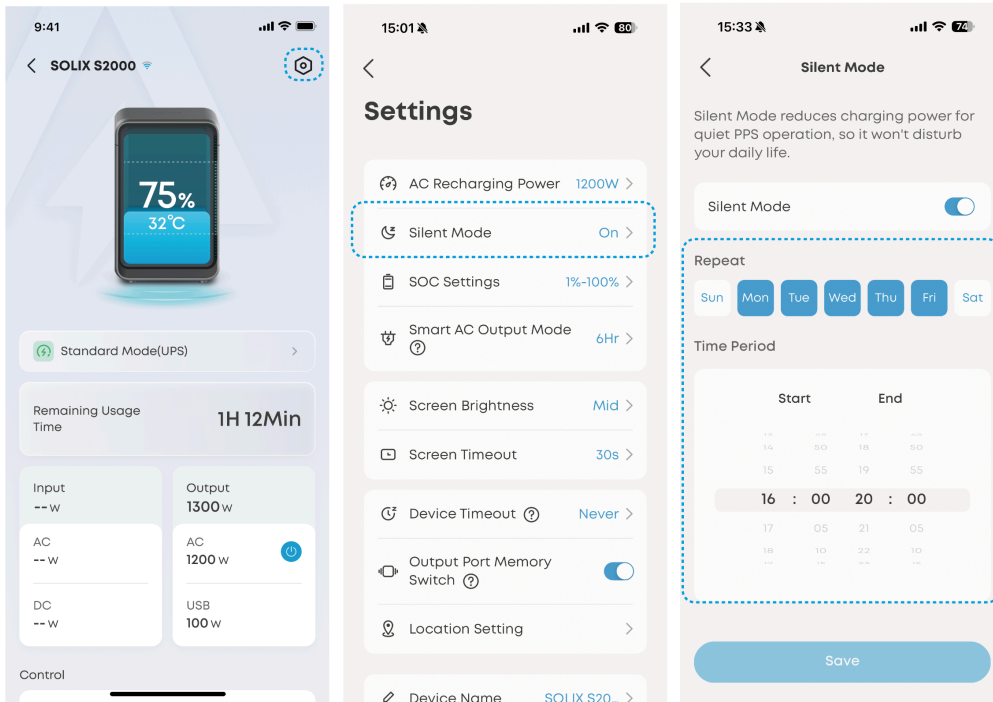

## SOC Settings

The upper charging limit and lower discharging limit of the power station can be set in the app. When recharging the power station, once the selected upper charging limit is reached, the recharging will automatically stop. When charging a device by power station, it will stop once the selected lower discharging limit is reached. This feature allows the battery to improve performance.

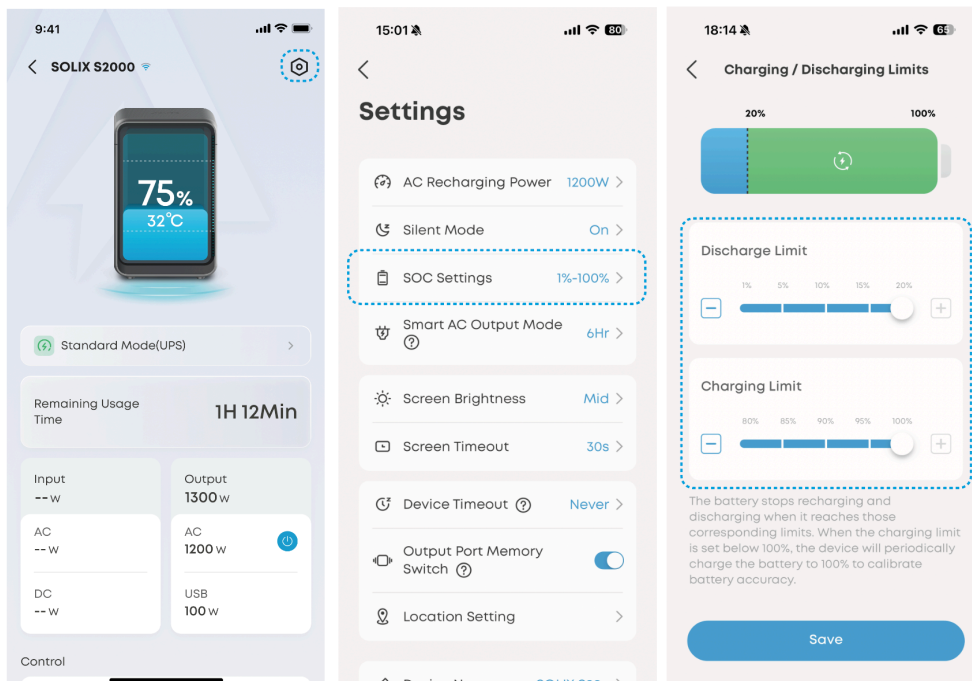

## AC Output Schedule

Set a timer to automatically turn AC output on or off at a scheduled time.

1. On the home screen, select **AC Output Schedule**.
2. Tap **Add Timing**.
3. Set the desired time, AC output state (On/Off), and repeat frequency. Then tap **Save**.

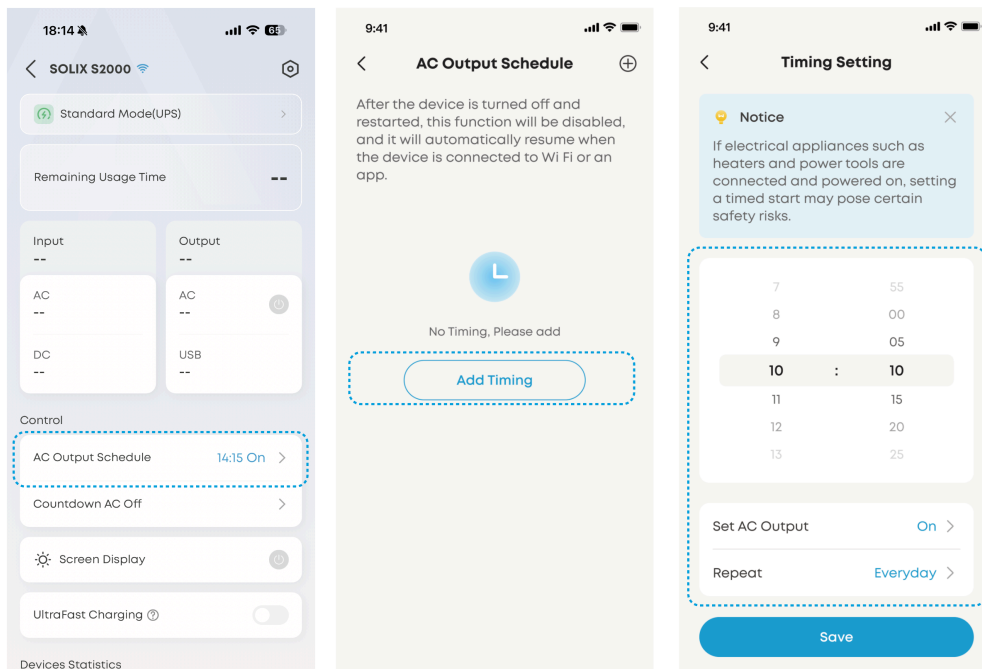

## Output Port Memory

The output port memory switch can be turned on or off in the app.

**On:** If the power station is powered off due to abnormal operating conditions or low battery level, it will automatically memorize the on/off status of AC output. When the power station is recovered to a normal condition or recharged to the State of Charge (SOC) lower limit plus 10%, the on/off status of AC and DC output ports will be restored.

**Off:** The power station will not automatically memorize the on/off status of AC output.

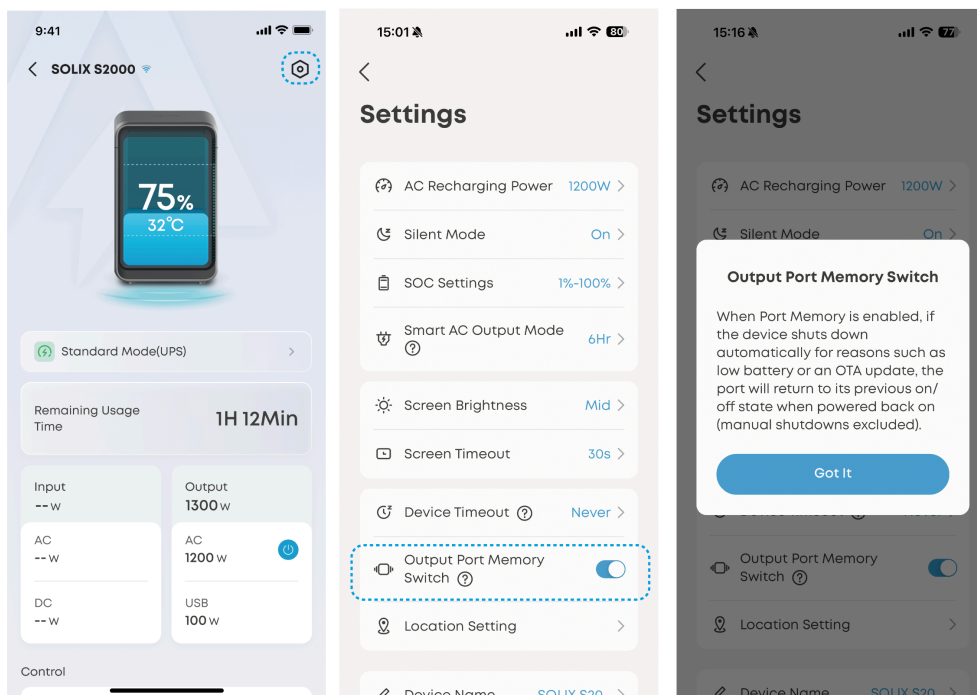

# Selecting Power Mode

## Standard Mode (UPS)

Standard Mode (UPS) is the default operating mode. The device prioritizes powering the connected load while charging simultaneously via AC or DC input when available. In case of a sudden blackout, the device will switch to battery power to keep connected devices running without interruption.

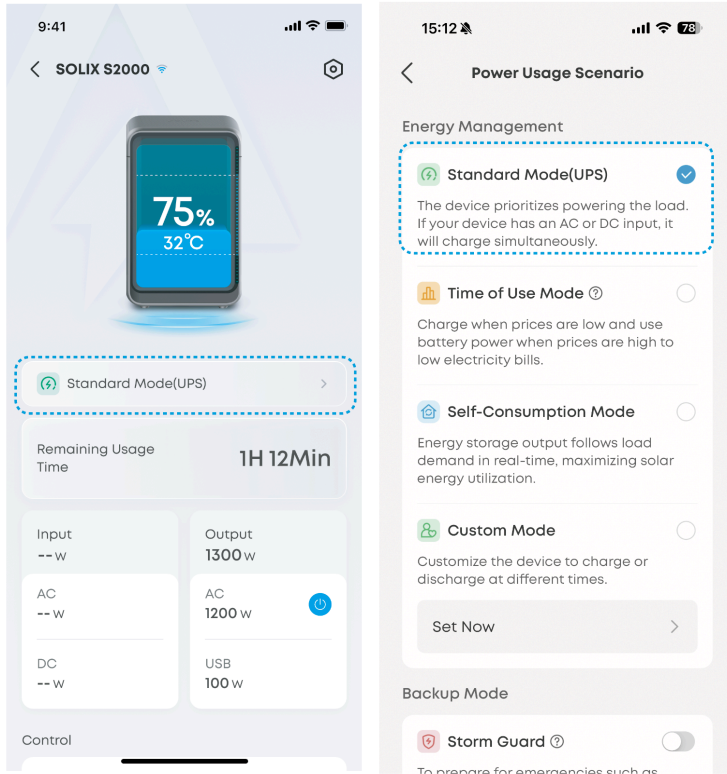

## Time-of-Use (TOU) Mode

Set time-of-use periods for automatic power scheduling to minimize costs. The power station will schedule its battery charging and discharging depending on the period settings.

Under this mode:

- If the power station's state of charge (SOC) is below the Backup Power level, the power station will function the same as the Standard Mode.
- If the SOC is higher than the Backup Power level, the power station will adopt different power use strategies in different TOU periods.

Period	AC Output Ports	DC Output Ports	Power Station Recharging
Peak	Power source priority: 1. Photovoltaic Power 2. Power Station Batteries 3. Grid	Power source: Power Station	Power source: Photovoltaic Power (excess power beside load demand) (Power Station will not be charged from the grid when its SOC is higher than the Backup Power level.)

<b>Mid-Peak</b>	Power source priority: 1. Photovoltaic Power 2. Grid(Power Station will not supply power to AC output ports.)	Power source: Power Station	Power source: Photovoltaic Power (excess power beside load demand) (Power Station will not be charged from the grid when its SOC is higher than the Backup Power level.)
<b>Off-Peak</b>	Power source priority: 1. Photovoltaic Power 2. Grid(Power Station will not supply power to AC output ports.)	Power source:Power Station	Power source priority: 1. Photovoltaic Power (excess power beside load demand) 2. Grid

### How to Set Up:

1. Select **Time of Use Mode**.
2. Edit time periods by dragging the slider. Tap **Add Time Period** to include additional periods. Repeat this for weekends if necessary.
3. Enter the rate pricing. Set unique "buy" and "sell" prices for each time period.
4. Review and save your settings.

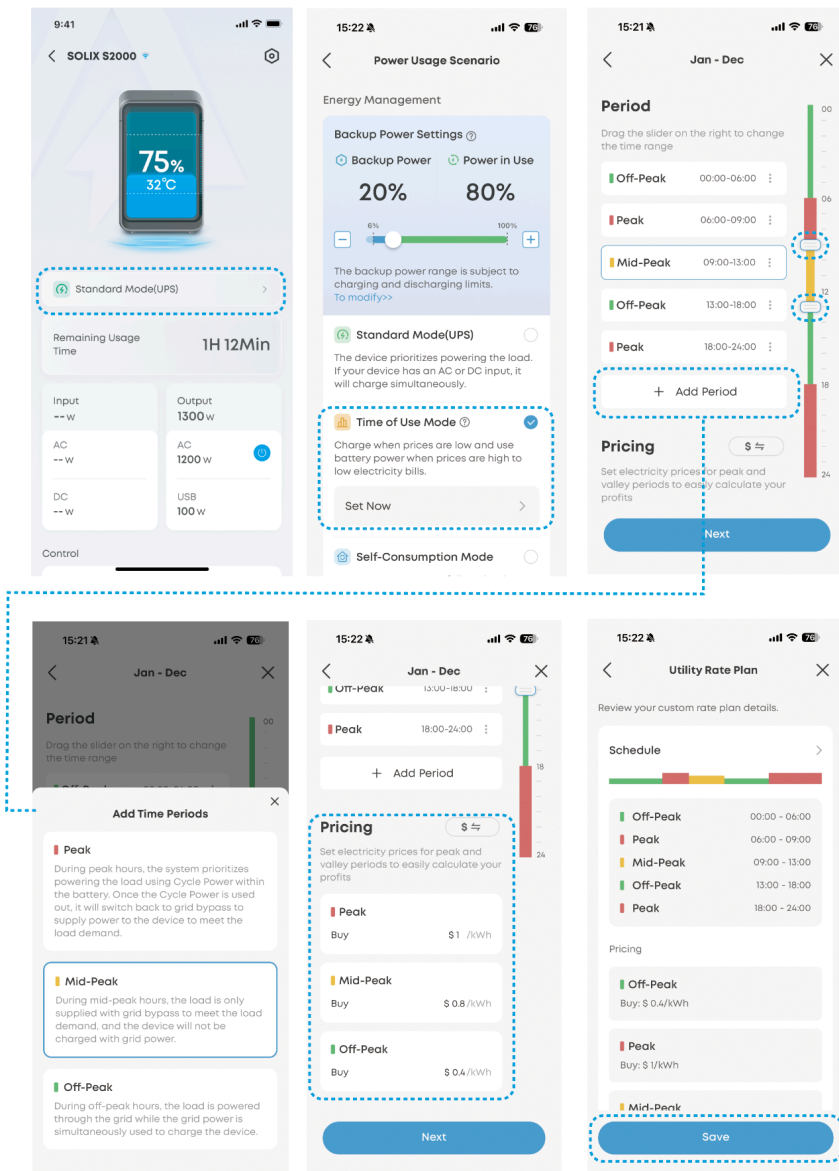

## Self-Consumption Mode

Self-Consumption Mode maximizes your use of solar energy and minimizes reliance on the grid.

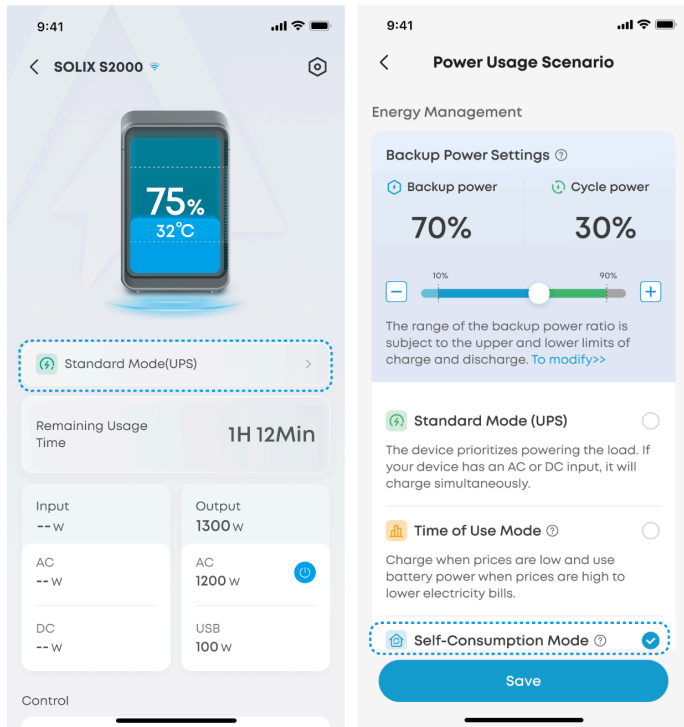

## Custom Mode

Customize power output based on your specific needs throughout the day. In this mode, you can set a 24/7 schedule of photovoltaics consumption and storage for the power station.

### How to Set Up:

1. Select **Custom Mode**.
2. Tap **Add Schedule**, then select the specific days of the week and time periods for plan execution.
3. Save and apply the energy plan.

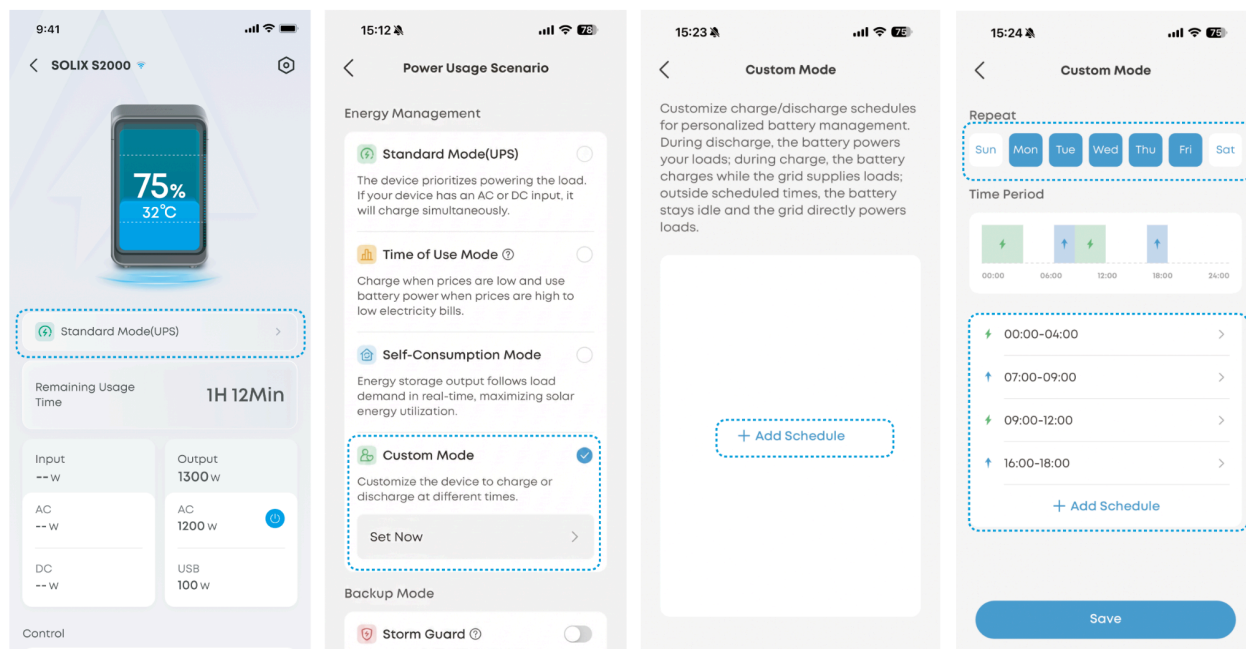

# Backup Mode

## Storm Guard

When Storm Guard is enabled, the power station will receive weather notifications based on your location and perform recharging at the fastest speed before severe weather. Under this mode, the power station will be fully charged regardless of the preset charging limit or AC recharging limit.

### How to Set Up:

1. Toggle on **Storm Guard Mode**.
2. Authorize location access.

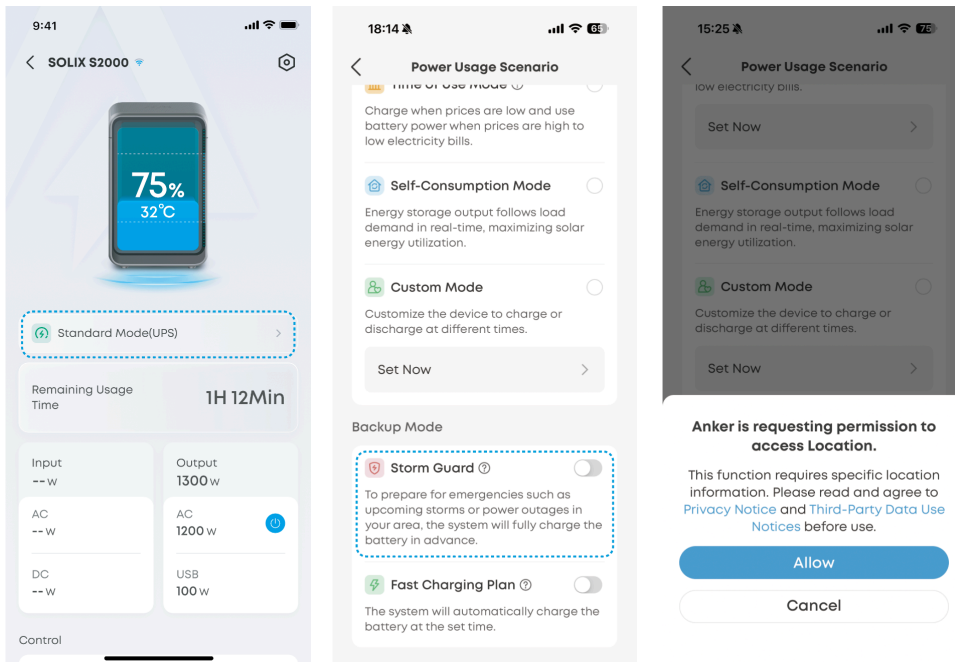

## Fast Charging Plan

When Fast Charging Plan is enabled, the power station will perform recharging at the fastest speed in the time periods you set. Under this mode, the power station will be fully charged regardless of the preset charging limit or AC recharging limit.

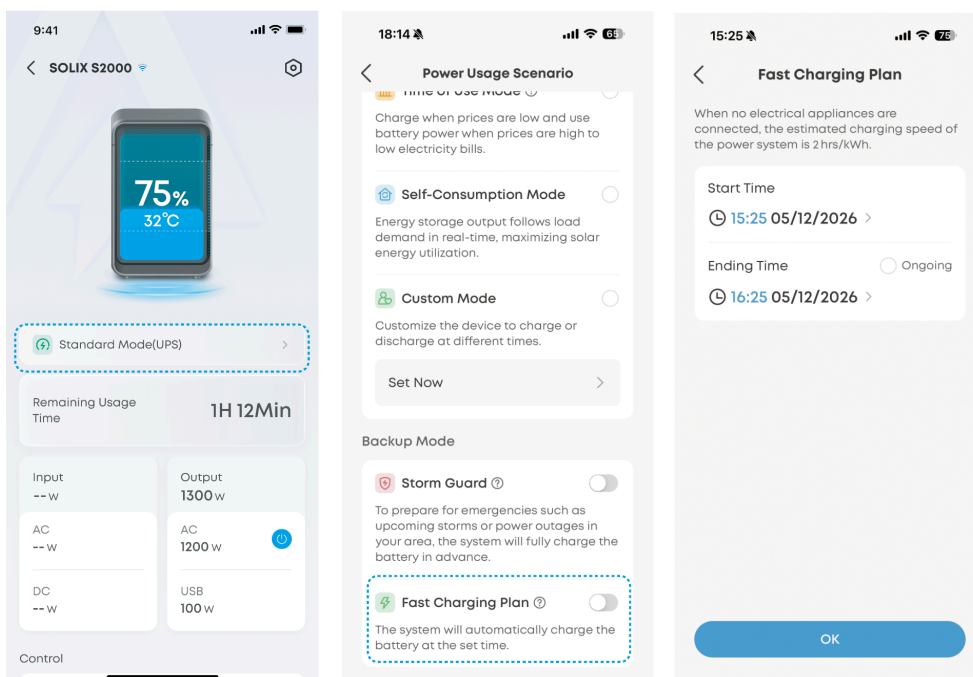

# Specifications

<b>Rated Battery Capacity</b>	6.4VDC / 314Ah / 2,010Wh
<b>AC Input Power (Charging)</b>	120V~9.58A, 60Hz, 1150W Max., L+N+PE
<b>AC Input Power (Ultra Fast Charging)</b>	120V~13.33A, 60Hz, 1600W Max., L+N+PE
<b>AC Input / Output Power (Bypass Mode)</b>	120V~15A Max. (<3hours), 1800W Max., 12A (continuous, ≥3hours), 60Hz, L+N+PE
<b>XT60i Input</b>	11-60V= 12.5A max.(400W Max)
<b>All AC Output Port (Inverter Mode)</b>	120V~12.5A, 60Hz, 1500W Total.
<b>USB-A1 Output</b>	5V=2.4A (12W Max.)
<b>USB-C1 Output</b>	5V=3A (15W Max.)
<b>USB-A1 and USB-C1 Total Output</b>	5V=3.6A (18W Max.)
<b>USB-C2 Output</b>	5V=3A/9V=3A/15V=3A/20V=3A/20V=5A(100W Max.)
<b>Discharging Temperature</b>	-4°F to 104°F / -20°C to 40°C
<b>Charging Temperature</b>	32°F to 104°F / 0°C to 40°C

## Default Exposed Network Interfaces and Services

Bluetooth Low Energy (BLE) Status: When the equipment is not yet connected to a network, it will automatically enable BLE broadcasting and activate BLE services to provide Bluetooth network configuration capabilities.

**Note:** During the BLE configuration process, ensure your network environment is stable and follow the instructions to complete the setup.